

DENON

STEREO CASSETTE TAPE DECK
MAGNETOPHONE A CASSETTE STEREO
STEREO-CASSETTENDECK

DR-M33HX/DR-M44HX

OPERATING INSTRUCTIONS
MODE D'EMPLOI
BEDIENUNGSANLEITUNG

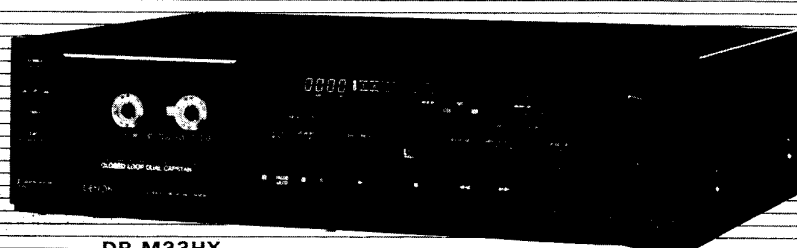

DR-M33HX

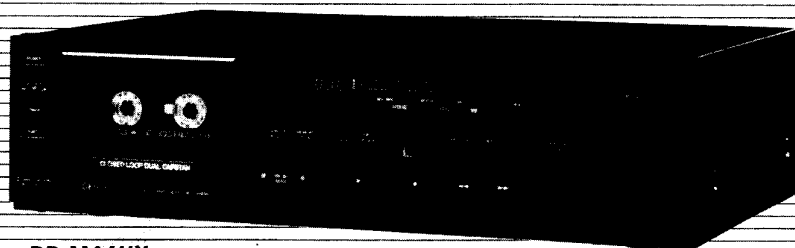

DR-M44HX

FOR ENGLISH READERS
POUR LES LECTEURS FRANCAIS
FÜR DEUTSCHE LESER

PAGE 1 ~ PAGE 19
PAGE 20 ~ PAGE 37
SEITE 38 ~ SEITE 56

IMPORTANT TO SAFETY

WARNING :

TO PREVENT FIRE OR SHOCK HAZARD, DO NOT EXPOSE THIS APPLIANCE TO RAIN OR MOISTURE.

CAUTION :

1. Handle the power supply cord carefully

Do not damage or deform the power supply cord. If it is damaged or deformed, it may cause electric shock or malfunction when used. When removing from wall outlet, be sure to remove by holding the plug attachment and not by pulling the cord.

2. Do not open back plate

In order to prevent electric shock, do not open the back plate. If problems occur, contact your DENON dealer.

3. Do not place anything inside

Do not place metal objects or spill liquid inside the cassette deck. Electric shock or malfunction may result.

Model DR. _____ Serial No. _____

Please, record and retain the Model name and serial number of your set shown on the rating label.

IMPORTANT (BRITISH MODEL ONLY)

The wires in this mains lead are coloured in accordance with the following code:

Blue:	Neutral
Brown:	Live

The colours of the wires in the mains lead of this apparatus may not correspond with the coloured markings identifying the terminals in your plug proceed as follows. The wire which is coloured blue must be connected to the terminal which is marked with the letter N or coloured black.

The wire which is coloured brown must be connected to the terminal which is marked with the letter L or coloured red.

FOR YOUR SAFETY (AUSTRALIAN MODEL ONLY)

To ensure safe operation, the three-pin plug supplied must be connected only with a standard three-pin power point which is effectively earthed through the normal household wiring.

Extension cords used with the equipment must be three-core and be correctly wired to provide connection to earth. Wrongly wired extension cords are a major cause of fatalities.

The fact that the equipment operates satisfactorily does not imply that the power point is earthed and that the installation is completely safe. For your safety, if in any doubt about the effective earthing of the power point, contact a qualified electrician.

Thank you very much for purchasing the DENON component DR-M33HX/M44HX.

The DENON DR-M33HX/M44HX is a top-line stereo cassette tape deck, capable of outstanding performance in combination with high grade hi-fi systems.

DENON proudly presents this advanced tape deck to audiophiles and music lovers as a further proof of DENON's non-compromising pursuit of the ultimate in sound quality. The high quality performance and easy operation are certain to provide you with many hours of outstanding listening pleasure.

TABLE OF CONTENTS

FEATURES.....	3
SAFETY INSTRUCTIONS FOR AUDIO SET	4
SPECIFICATIONS	5
FRONT PANEL SWITCHES AND CONTROLS	6~7
CONNECTION.....	8
CASSETTE TAPE	9
AUTO TAPE SELECT FEATURE	9
PLAYBACK	10
RECORDING	11
AUTO TUNING SYSTEM (DR-M44HX only)	12~13
CENTRALIZED DISPLAY	14
PROPER RECORDING LEVEL	14
RECORDING BIAS ADJUSTMENT (DR-M33HX only).....	15
MONITOR SWITCH	15
TIMER RECORDING/PLAYBACK	16
PAUSE/MUTE KEY.....	17
DOLBY HX PRO HEADROOM EXTENSION SYSTEM.....	17
DOLBY C NOISE REDUCTION SYSTEM	17
MAINTENANCE	18
SYMPTOMS OFTEN MISTAKEN AS BREAKDOWNS	19

FEATURES

- Computer-controlled servo technology
 - Direct drive closed-loop dual-capstan tape transport (DR-M44HX)
 - Closed-loop dual-capstan tape transport (DR-M33HX)
 - Silent, soft-touch controls provide maximum ease-of-use.
 - Computer-controlled, full-logic tape controls enable fool-proof operation.
 - Three-head design utilizes the DENON's new SF record/playback combination head assembly.
 - Dolby HX PRO headroom extension.
 - Computerized Linear counter with memory stop.
 - Auto tuning system provides automatic level and EQ adjustment. (DR-M44HX)
 - Dolby-B/C noise reduction systems (Double Dolby System).
 - Extended range, dual-color fluorescent peak meters with auto peak hold.
 - Auto tape selector.
 - Remote control connection terminal.
 - High-grade 5-pole DC reel drive motor.
 - Bias fine adjustment (DR-M33HX).
- Dolby noise reduction and HX PRO headroom extension manufactured under license from Dolby Laboratories Licensing Corporation. HX PRO originated by Bang and Olufsen. "Dolby", the double-D symbol and "HX PRO" are trademarks of Dolby Laboratories Licensing Corporation.

SAFETY INSTRUCTIONS FOR AUDIO SET

■ INSTALLATION

1. Operate the set only from a power source which is indicated on the rating label (indication) at the back of the set.
2. Frayed cords and broken plugs may cause a fire or shock hazard. Do not damage the power cord.
 - Do not cut and splice the power cord.
 - When removing the power cord from wall outlet, be sure to unplug by holding the plug attachment and not by pulling the cord. Do not hold the plug by wet hand.
 - Call your service technician for replacement of damaged cords and plugs.

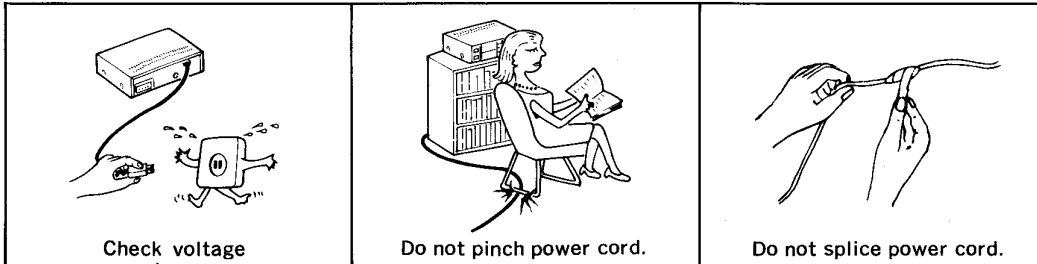

3. Select a place so that the location or position does not interfere with the proper ventilation of the set for releasing heat generated during operation.
 - Select a flat and level surface allowing enough space for setting up and operation.
 - Never block the bottom ventilation holes placing the set

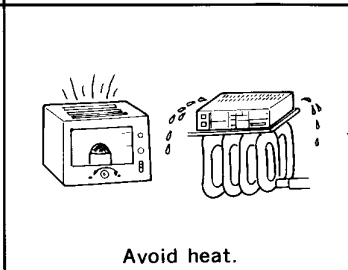

- on a bed, sofa, rug, etc.
- Never place the set in a "built-in" enclosure unless proper ventilation is provided.
- Never place the set near or over a radiator, heat register or stove.
- Avoid locations where the set is exposed directly to the sun light.

■ USE

1. Do not expose the set to rain or water (liquid). Do not spill liquid or insert metal objects inside the set. Rain, water or liquid such as cosmetics as well as metal may cause electric shorts which can result in fire or shock hazard. If anything gets inside, unplug the power cord and have a **DENON** service technician check your set before further use.
2. Never leave your set switched on when leaving the house. For added protection of your audio system during lightning storm or when the set is to be left unused for a long period of time, be sure to unplug the power cord from the wall outlet.
3. Take care so that the set is not dropped to avoid damaging the cabinet which defeats safeguards or injuring yourself. If the set has been dropped or the cabinet has been damaged, unplug the set and have it checked by a **DENON** service technician to restore the safeguards.

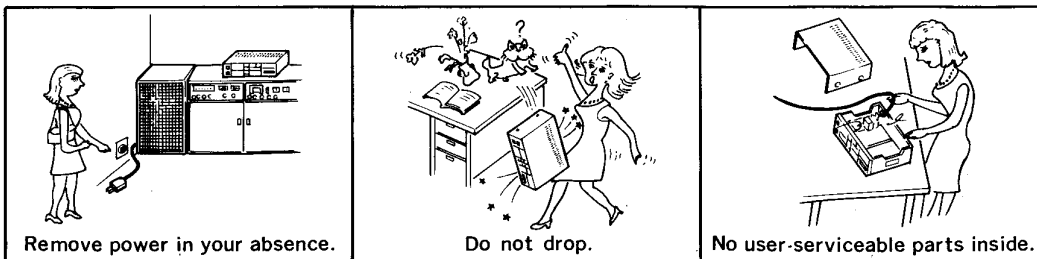

■ SERVICING

1. The servicing of set must not be attempted by yourself beyond that described in the operating instructions. In case of problems that cannot be settled by referring to your operating instructions, unplug the power cord and contact your **DENON** dealer. No user-serviceable parts are inside the set. Only qualified service technician can service inside your set.
2. Refer to the operating instructions for maintenance and cleaning.

SPECIFICATIONS

- Type Vertical tape loading 4-track 2-channel stereo cassette tape deck
- Heads SF Record/Playback Combination head × 1
Erase head (Ferrite) × 1
- Motors FG Servo Direct Drive motor (for capstan) × 1 (DR-M44HX)
Electronic servo DC motor (for capstan) × 1 (DR-M33HX)
5-pole DC motor (for reel winding) × 1
- Tape Speed 4.8 cm/sec.
- Fast forward, rewind time. Approx. 80 sec. with a C-60 cassette
- Recording bias Approx. 105 KHz
- Overall S/N ratio..... Dolby C NR on ... 75 dB (CCIR/ARM)
(at 3% THD level)
- Overall frequency response. 25~20,000 Hz ±3dB (at -20 dB METAL tape)
- Channel separation..... more than 40 dB (at 1 KHz)
- Crosstalk..... more than 65 dB (at 1 KHz)
- Wow & flutter 0.035% w.rms (DR-M44HX)
0.04% w.rms (DR-M33HX)
- Inputs
line 77.5 mV (-20 dB) input level at maximum
Input impedance: 50 Kohm unbalanced
- Outputs
line 775 mV (0 dB) output level at maximum (with 47 Kohm load,
recorded level of 200 pwb/mm)
headphone 1.2 mW output level at maximum (optimum load impedance 8 ohm
~1.2 Kohm)
- Accessories Parallel pin cord × 2
- Power supply 50 Hz/60 Hz compatible, voltage is shown on rating label
- Power consumption 25 W (DR-M44HX), 24 W (DR-M33HX)
- Dimensions..... 434 (W) × 115 (H) × 286 (D) mm
- Weight..... 5.6 kg

■ Above specifications and design styling are subject to change for improvement.

FRONT PANEL SWITCHES AND CONTROLS

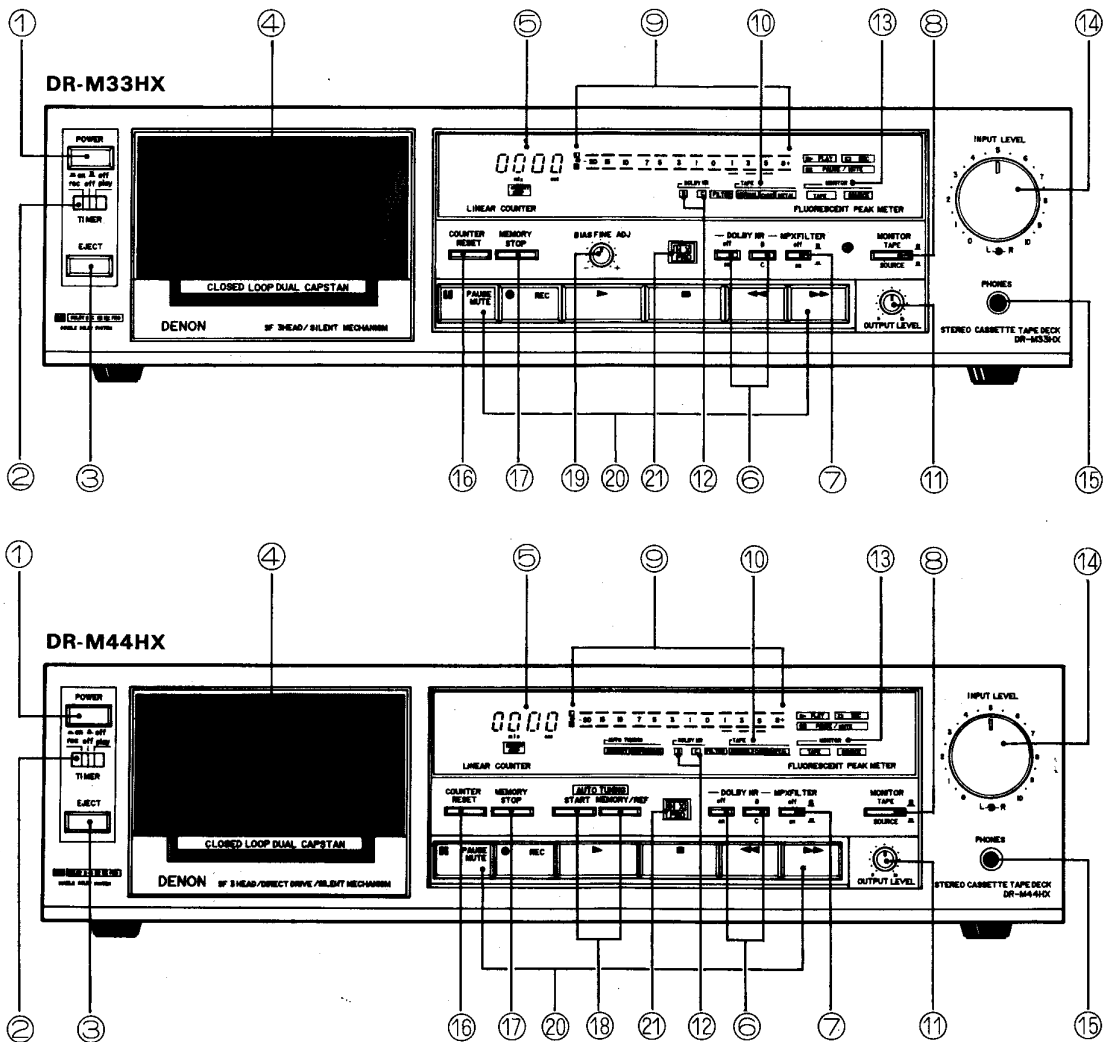

Fig. 1

1. POWER switch

Controls the supply of AC power to the deck. One push turns the deck on, a second push turns it off. The deck remains in a stand-by (non-operative) mode for approximately 4 seconds after it is switched on.

2. TIMER switch

This switch is provided for use with an optional audio timer for unattended recording or morning-alarm playback. For non-timer operation, this switch should be set in the "off" position (see page 16):

3. EJECT button

Press this button to eject the cassette. When the deck is operating (tape is running), press the stop (■) key first to stop the tape transport; then press the EJECT button.

4. CASSETTE COMPARTMENT COVER

If this compartment cover is not closed completely, the deck's transport controls will remain inoperative.

5. LINEAR TAPE COUNTER

Tape passage is indicated digitally in minutes and seconds. (See Page 14)

6. DOLBY NR switches

The left Dolby NR switch activates (in) or deactivates (out) the deck's Dolby noise reduction circuitry. The right switch selects between Dolby B-Type (out) or C-Type NR (in). (see page 17).

7. MPX FILTER switch

The MPX FILTER switch should be used to prevent interference with the Dolby NR circuit

when making Dolby NR encoded recordings of FM stereo programs. When making Dolby NR encoded recordings from any program source other than FM stereo, leave this switch in the "off" (out) position.

8. MONITOR switch

The SOURCE (in) position of this switch allows you to monitor the source program before it is recorded. The TAPE (out) position of this switch is used for tape playback monitoring or simultaneous monitoring during recording (see page 15).

9. FLUORESCENT PEAK METERS

These meters indicate recording or playback peak levels for each channel. For peak levels exceeding -1 dB, the Auto Peak Hold feature holds the peak level reading for approximately 1.5 seconds.

10. TAPE SELECT indicator

This indicator light is interlocked with the Auto Tape Select feature which automatically adjusts the deck to the type of tape in use. (NORMAL, CrO₂, or METAL).

11. OUTPUT LEVEL control

This control adjusts playback, recording monitor, and headphones output levels for the both channels simultaneously.

12. NR SYSTEM indicator

This indicator light is interlocked with the Dolby NR switch and informs the user that Dolby NR is in use as well as which (B or C) Type.

13. MONITOR indicator

This indicator light is interlocked with the

MONITOR switch to inform the use of the selected monitoring source—TAPE or SOURCE.

14. INPUT LEVEL controls

These controls are used to adjust recording levels for each channel. The front control is for the left channel; the rear control for the right channel (see page 14).

15. PHONES jack

For private music enjoyment without disturbing others, or for monitoring a recording, a set of headphones may be plugged in. Impedance should be from 8 to 1200 ohms.

16. RESET button

Operation of the button resets the counter to all zero.

17. MEMORY STOP button

During rewinding operations, the tape will stop at the "0000" counter point automatically when this button is pressed in.

18. AUTO TUNING system (DR-M44HX only)

By pushing this button, the deck automatically adjusts itself for the optimal recording characteristics of the tape that is being used.

19. Bias Fine Adjustment (for NORMAL and CrO₂ tape) (DR-M33HX only)

Adjust the bias according to the tape characteristics. Standard biasing is obtained at the center click-stop position. (see page 15).

21. HX PRO indicator

This indicator lights when the power is on to indicate provision of the HX-PRO headroom extension system.

20. Tape transport controls

▶	▶ PLAY KEY	Press to playback tape.
■	■ STOP KEY	Press to stop tape in any mode.
◀◀	◀◀ REW KEY	Press for fast rewind.
▶▶	▶▶ FF KEY	Press for fast forward tape winding.
● REC	● RECORD KEY	To begin recording, press the RECORD and PLAY keys simultaneously. If only the RECORD key is pressed, the deck is placed in the REC PAUSE (record standby) mode.
PAUSE MUTE	PAUSE/MUTE KEY	The PAUSE key causes the tape to stop momentarily during recording or to mute the recording input to create blank (non-recorded) portions on the tape (see page 17).

CONNECTION

- Leave your entire system (including this cassette deck) turned off until all connections between the deck and other components have been made.

■ Connecting the deck to an amplifier and attaching the remote control unit

- Before connecting the deck to your amplifier, it is a good practice to review your amplifier's instruction manual.
- Use the white plugs for the left channel, and the red plugs for the right channel.
- An optional remote control unit (RC-57) can be attached to the rear DIN connector of the deck for remote operation.

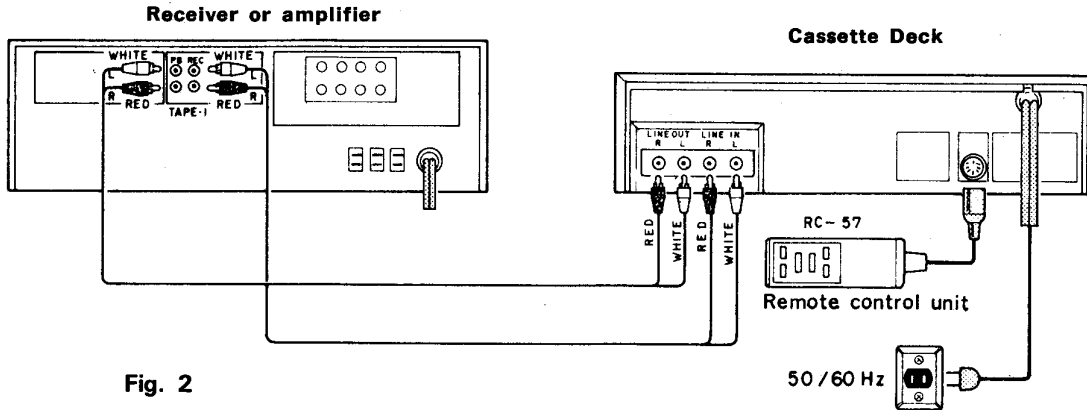

Fig. 2

■ Connecting Headphones

To listen through headphones, plug your headphones into the PHONES jack.

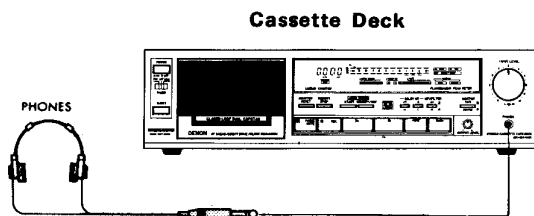

Fig. 3

■ Connection to Another Tape Deck

When dubbing to or from another tape deck, connect this cassette deck as illustrated below:

Many stereo amplifiers and receivers have tape dubbing circuitry so that tape duplication can be performed between two or more tape decks. Review your amplifier's instruction manual for a full explanation of this mode of operation.

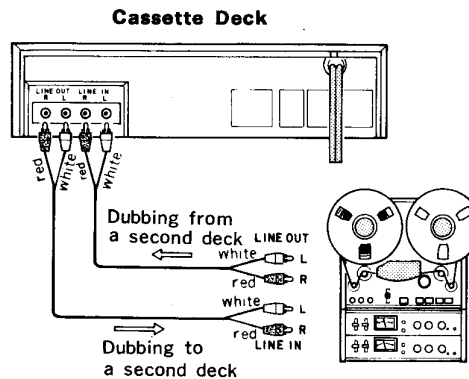

Fig. 4

■ Installation Precautions

If the deck is placed on or too near an amplifier or tuner, noise (induced hum) or beat interference may result (especially during AM reception). If this occurs, separate the deck from other components or reorient its position.

CASSETTE TAPE

■ Handling Precautions

- C120 cassettes
C120 cassettes are not recommended as they use a very thin tape base which may become tangled around the capstan or pinch roller.
- Tape slack
Before putting a tape into the deck, take up any slack with a pencil or your finger tip. This precaution is also to prevent the tape from becoming entangled around the capstan or pinchroller.

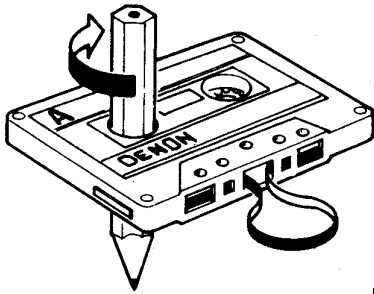

Fig. 5

■ Storage Precautions

- Do not store cassette tapes in a place where they will be subject to:
 - Extremely high temperature or excessive moisture
 - Excessive dust
 - Direct sunlight
 - Magnetic fields (near TV set or speakers)
- To eliminate tape slack, store your cassettes in cassette cases with hub stops.

■ Accidental Erasure Prevention

- Every cassette has erasure prevention tabs for each side. To protect your valuable recorded tapes from accidental or inadvertent erasure, remove the tab for the appropriate side with a screwdriver or other tools.
- To record on a tape with the erasure prevention tabs removed, cover the tab holes with plastic tape.

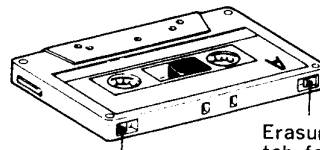

Erasure prevention tab for side B
Erasure prevention tab for side A

Fig. 6

AUTO TAPE SELECT FEATURE

This Stereo Cassette Deck is equipped with an Auto Tape Select feature which automatically selects the optimum bias and equalization for the tape in use. This is accomplished by sensing the tape type detection holes in the cassette housing. The Tape type (NORMAL, CrO₂, or METAL) is indicated by the TAPE SELECT indicator.

- If a tape without tape type detection holes is used, the TAPE SELECT indicator will not indicate the correct tape type and the deck will automatically adjust itself for normal tapes.

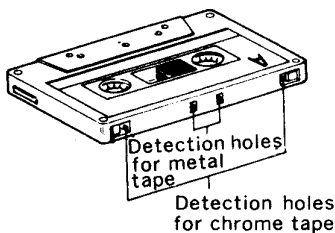

Fig. 7

- If the deck is switched on with no cassette loaded, the TAPE SELECT indicator will show "METAL".

- For the details of FeCr tape, see the "AUTO TUNING SYSTEM" on page 12. (DR-M44HX only)

Brand	NORMAL	CrO ₂	METAL
DENON	DX3 ※DX 3H	DX7 ※HD 7E	※DXM
MAXELL	UL UD I XL I XL I S	XL II XL II S	MX
TDK	AD OD	SA SA-X	MA MA-R
FUJI	DR ER	FR-II	FR METAL
SCOTCH	BX CX	XS-II	
SONY	AHF HF	UCX UCX-S	METALLIC

- Typical tape brands for each type are listed in the above table. There may be differences in sensitivity of a few decibels between tape brands.
- This Cassette Deck is optimally aligned for tapes marked with "※".

PLAYBACK

- Switch on your amplifier or receiver.
- Set the TAPE MONITOR switch on your amplifier or receiver to the TAPE position.
- Operate the deck in numerical order as illustrated below:

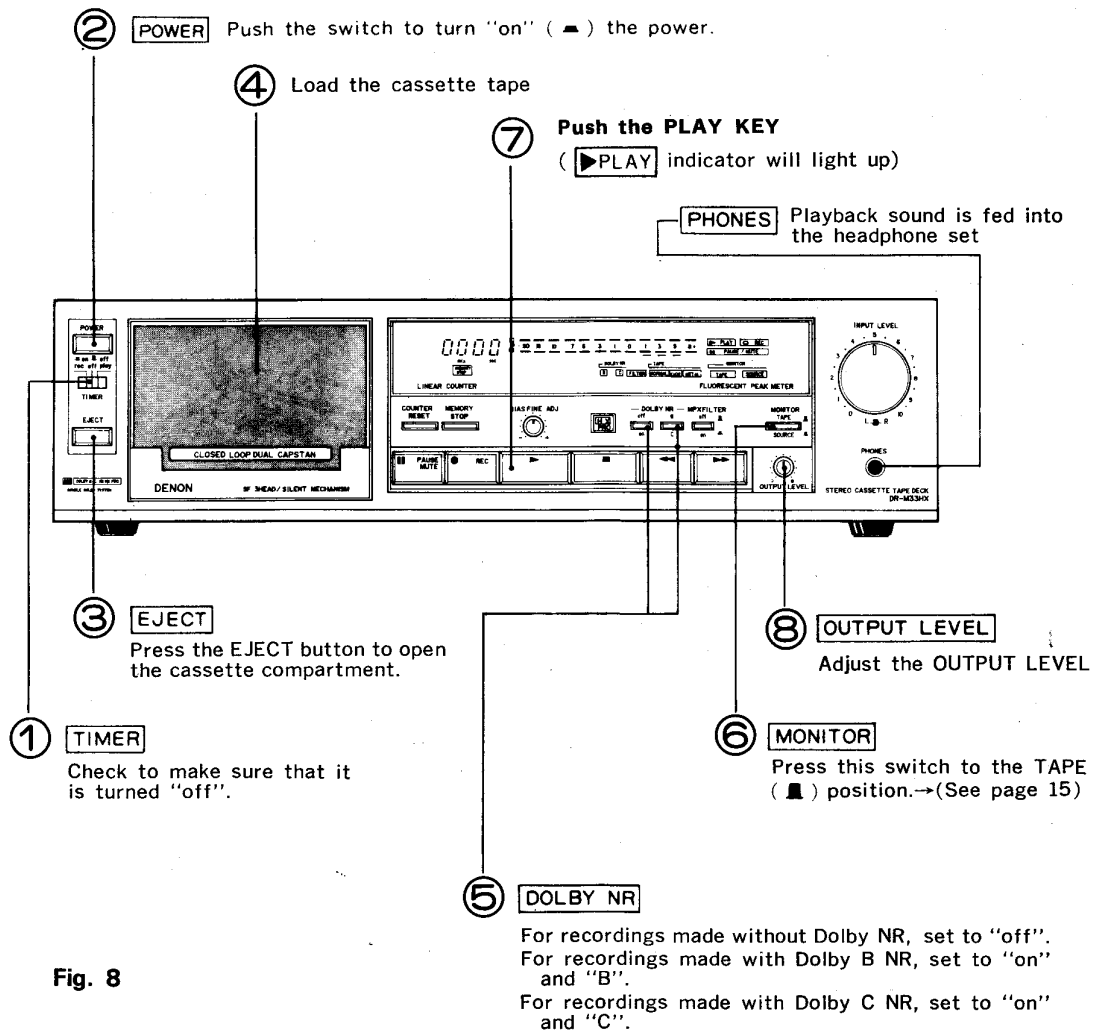

Fig. 8

When playback is finished, press the stop (■) key. To pause during playback, press the PAUSE/MUTE (▬▬) key. To restart the tape, press the PLAY (▶) key.

If different types of Dolby Noise Reduction are used for record and playback, playback response will be adversely effected.

RECORDING

- Switch on the source component (tuner, amplifier, etc.)
- Set the TAPE MONITOR switch on your amplifier or receiver to the SOURCE position.

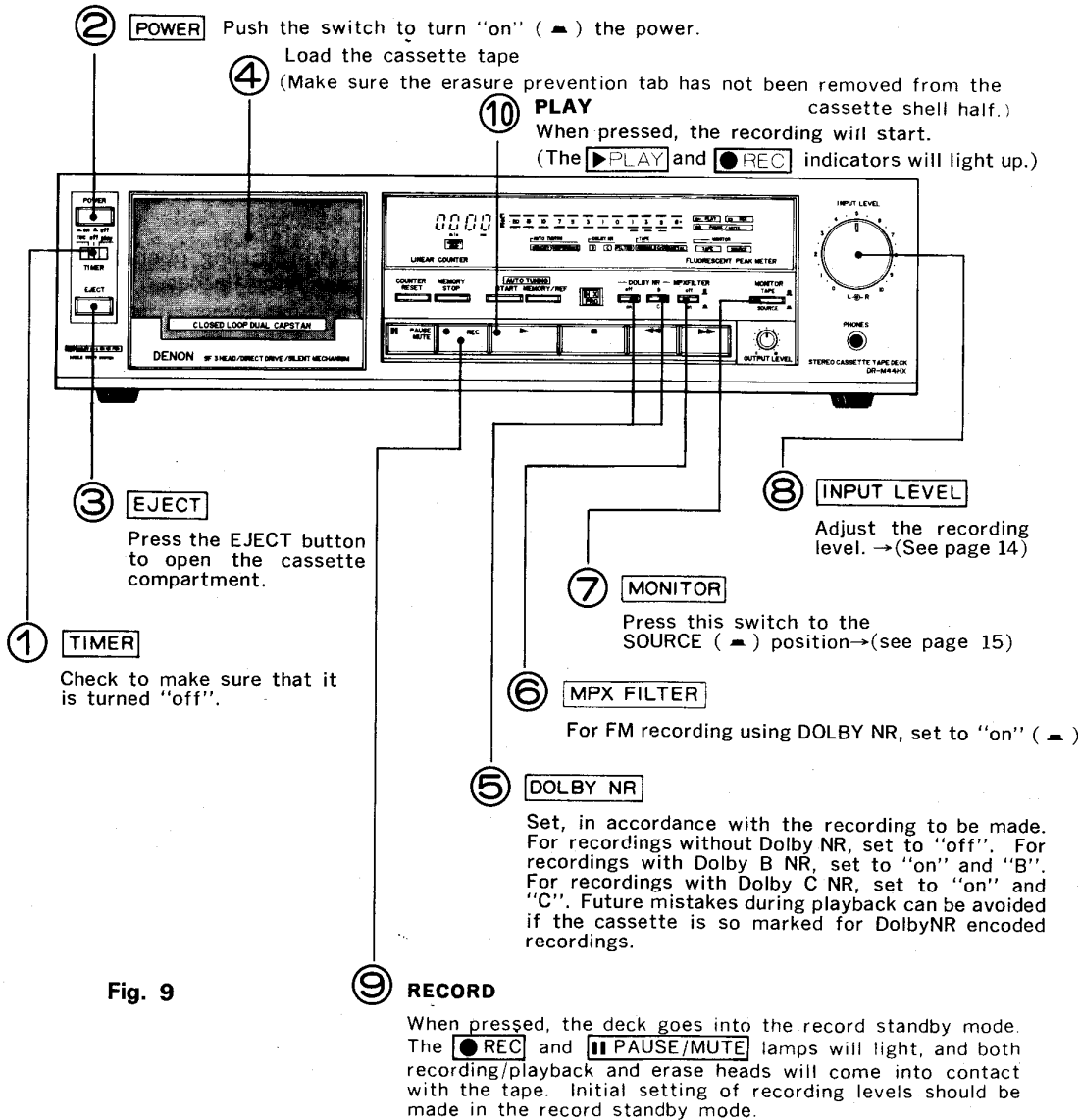

Fig. 9

When recording is finished, press the STOP (■) key.

■ Instant playback to recording mode

To start recording right after previously recorded material on a tape, this feature is quite convenient.

1. Play the section of the tape with previously recorded program material.
2. When the previously recorded material finishes, press both the RECORD (●) key and the PLAY (▶) key at the same time. Without stopping, the deck will go from the playback to the recording mode, and the ● **REC** indicator lamp will go on.

Caution:

Be careful not to erase important recordings by mistake. Mis-erasing can be avoided, if you remember the two steps below:

1. If the PLAY (▶) key is pressed while the ● **REC** indicator is on, the tape will be recorded.
2. If the PLAY (▶) and RECORD (● **REC**) key are pressed at the same time, the tape will be recorded.

AUTO TUNING SYSTEM (DR-M44HX only)

The same type of tapes can have slightly different performance characteristics depending on the tape brand or individual tape characteristics. This occurs even though the deck automatically selects bias according to type of the tape placed in the deck. The auto tuning system automatically further fine tunes the deck to achieve the optimum recording response according to individual tape characteristics, and stores this information in its memory.

Auto Tuning System Controls and Indicators

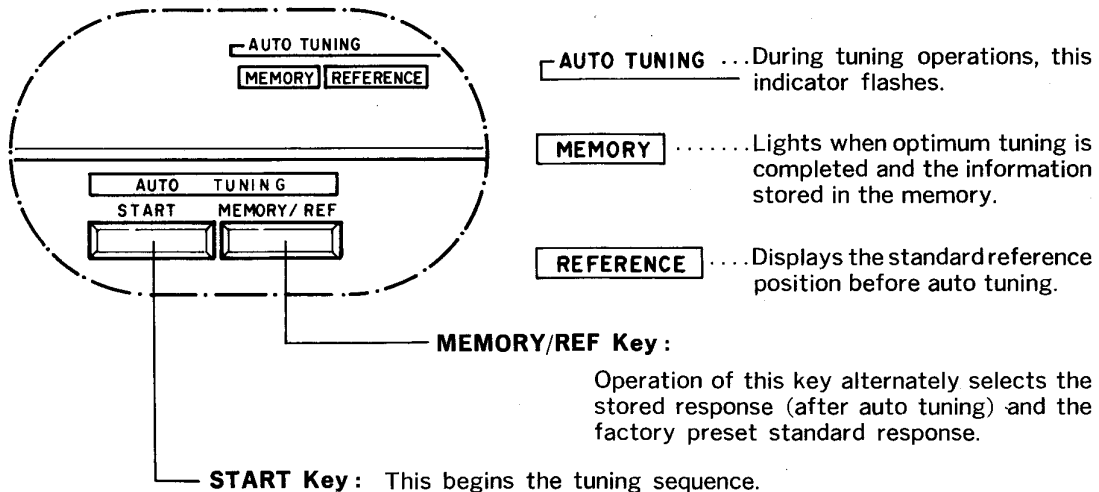

Fig. 10

Auto Tuning System Operation

1. Place the cassette. (The TAPE SELECT indicator will indicate the tape type).
2. When the MEMORY STOP indicator is lit, press the memory stop button to deactivate this function during Auto Tuning. If not deactivated, it will interfere with the tuning operation.
3. Press the START key.

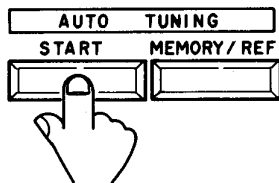

Fig. 11

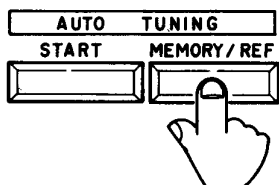







Fig. 12

- (1) Tuning begins and the AUTO TUNING indicator lamp starts flashing. (The deck enters the record mode.)
- (2) When tuning is completed after approximately 6 seconds, the tape is automatically rewound to a point just preceding the original start point. The tuned response is stored in the memory. (The MEMORY lamp comes on and the deck returns to the STOP mode.) The deck is now ready for recording.
- (3) Tuned response (MEMORY) and standard response (REFERENCE) can be alternately selected by pressing the MEMORY/REF key.

- The auto tuning system can store one optimized recording response setting each for NORMAL, CrO₂ and METAL positions. (e.g.)

Tape position		NORMAL	CrO ₂	METAL
AUTO TUNING	START → MEMORY Optimum recording response	Memory 	Blank 	Memory 
REFERENCE	Preset standard response	 (DX 3H)	 (HD 7E)	 (DX M)

- For tape positions with optimum recording responses stored in the memory, the MEMORY and STANDARD responses can be alternately selected by pressing the MEMORY/REF key. (The MEMORY and REFERENCE indicator lamps correspond to the selected key position.)
- For a tape position (CrO₂ in this example) with no optimum response stored, a new tape response can be quickly determined and stored in the memory.
- When a tape response for each of the three positions is stored in the memory, six different recording responses can be selected.

- If tuning is attempted more than once for the same type of tape, the optimized response for the last tape will remain in the memory and all the previous responses will be cleared.
- If the tape is started from the clear leader tape, the time that it takes for the leader tape to clear the heads will be added to the tuning time. In these cases, the tape will be rewound to a position just prior to the beginning of the magnetic tape. The counter may not indicate the original start position.
- Before the tuning sequence is performed, MEMORY response cannot be selected even if the MEMORY/REF key is pressed.
- All memory contents are cleared when the deck is switched off.
- If the START key is pressed during recording, the MEMORY response will automatically be switched into the STANDARD response.
- If the START key is pressed during playback of a recorded tape with the erasure prevention tab intact, the tuning sequence will begin and part of the recorded tape will be erased. Be sure to remove the erasure prevention tabs from recorded tapes.
- If the tape is too loose or too tight, the AUTO TUNING will not function properly. Take care to make sure that tape tension is even.
- If the MEMORY STOP function is activated during AUTO TUNING, it may interfere with the tape running of the tuning operation. Make sure MEMORY STOP is off before tuning is begun.

■ FeCr Tape

Since the Auto Tape Select feature does not have a separate position for FeCr, the optimum recording response for FeCr tapes will be achieved only if the Auto Tuning feature is used. (When playing a FeCr tape recorded on the DR-M44HX Deck on another deck, set the deck's tape selector to the NORMAL position).

CENTRALIZED DISPLAY

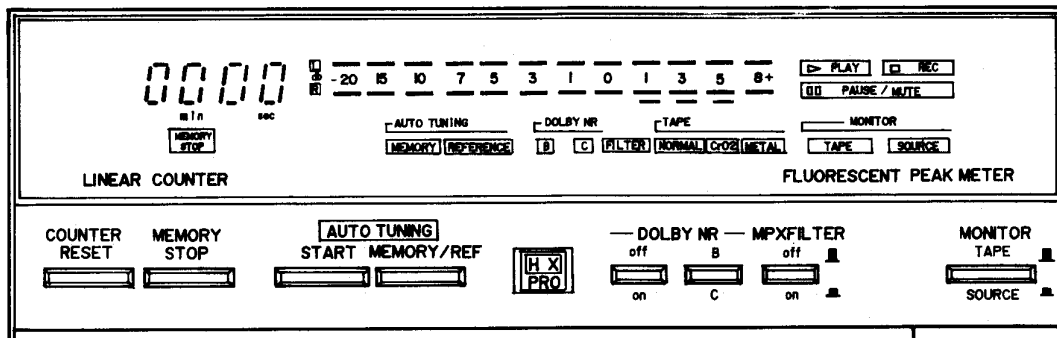

1) Operation of the Linear Tape Counter

- (1) Press the RESET button first to set the counter "0000".
- (2) Tape passage is counted in minutes and seconds during PLAY, FF, and REW modes.

Note There may be errors between the counter indication and the real recording time. This is inevitable to some extent due to the fact the counter indicates time during FF and REW as well as during recording and playback. The degree of error is different for different tapes.

- When the power switch is turned "off", the counter display turns off. When the deck is turned back "on", the counter is automatically reset to "0000". The reading of this counter does not correspond with that of any other deck.

2) Operation of MEMORY STOP

- (1) During recording or playback operations, MEMORY STOP can be used to locate a particular point on the tape. At the desired point, reset the counter to "0000". With the MEMORY STOP button in the "on" position, the deck will stop at the "0000" point (actually between "9955" and "0001") during REWIND operations.
- (2) The MEMORY STOP indication will light when this function is activated.
- (3) Notes:
 - When the power is turned "off", this function is automatically cancelled.
 - The MEMORY STOP is accurate to -5 on the counter, and will stop between "9955" and "0000".

3) Display Functions

- (1) The position of the tape in use is displayed automatically. NORMAL, CrO₂, or METAL indicators light in the display. A special indicator on the bar-graph level meter shows the limit of the upper region of the recommended recording level for each type of tape. The position of this indicator changes according to the type of tape in the deck. For NORMAL position tapes, the indicator is at the +1 dB point; for CrO₂ position tapes, the indicator is at +3 dB; and for METAL position tapes, the indicator is at +5 dB. In addition to the level indication, the meters also feature auto peak hold for easy and precise setting of recording levels.
- (2) If a blank space is to be made during recording, hold the PAUSE/MUTE key in. At this time, the PAUSE/MUTE indicator in the display will flash in one-second intervals.
- (3) The display features two-color lettering and indications for easy identification.

PROPER RECORDING LEVEL

A too high recording level can saturate the tape and cause distortion. On the other hand, if recording levels are set too low, soft passages will be marked by residual noise. Proper recording level is the single most important factor for making well balanced recordings.

- The tape select indicator adopted on this deck displays the tape type (NORMAL, CrO₂, METAL) in words. Also, a bar graph indicator shows the maximum recording level. Recording input levels can be set by matching with the reading of the PEAK LEVEL METER.

Table : Guideline for maximum recording level

Normal tape	+1 dB levels on peaks
CrO ₂ tape	+3 dB levels on peaks
Metal tape	+5 dB levels on peaks

Note : Optimum recording levels can differ depending on program sources or the type of tape used. Make trial recordings using the simultaneous monitoring. Refer to the description under "MONITOR SWITCH".

- For input levels between -1 dB and +8 dB, the Auto Peak Hold feature holds the peak level on the meter for approximately 1.5 seconds for easier reading.

● Meter reading difference between L and R channels

The left and right channel readings of the FL PEAK METER can differ in average due to variations in input signal levels. In such cases, adjust the individual channels of the INPUT LEVEL controls until equal meter readings are obtained for both channels.

RECORDING BIAS FINE ADJUSTMENT (DR-M33HX only)

For best recording results, monitoring during the recording process and comparing various recordings using your own judgement are essential.

The DR-M33HX is equipped with a bias fine adjustment control to assist you in setting the optimal bias for different types and brands of recording tape. At the center-stop position, the deck is set for a reference bias level for CrO₂ and NORMAL tapes. If the resulting recording in this position has too much or too little high frequency content, varying the bias fine adjustment control can be useful to achieve better results.

If the high frequencies (treble sounds) are to be boosted, turn the bias control counterclockwise to decrease bias current. If distortion is of more concern than high frequency response, turn the control clockwise to increase bias current. By the use of this control, you can record tapes with response that matches your personal listening tastes.

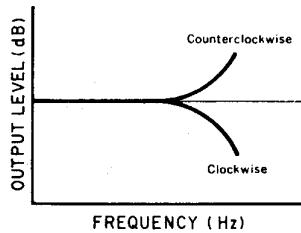
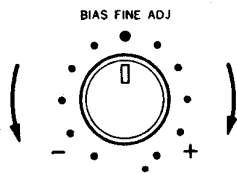

MONITOR SWITCH

This Stereo cassette deck uses a three-head system which permits simultaneous "off-the-tape monitoring" during recording. Use the MONITOR switch to select monitoring sources. The MONITOR indicator shows the selected monitoring source, "TAPE" or "SOURCE".

Recording	<p>Monitor Switch → "TAPE (■)"</p>	The signal recorded on the tape is monitored simultaneously "off-the-tape". This monitoring mode enables you easy check for optimum recording levels. In the "TAPE" mode, the FL PEAK METER indicates the signal levels played back off-the-tape.
	<p>Monitor Switch → "SOURCE (≡)"</p>	The SOURCE position enables you to monitor the input source signal before it is recorded on the tape. Using the FL PEAK METER, this mode is convenient for setting recording levels or input level monitoring during recording.
Playback	<p>Monitor Switch → "TAPE (■)"</p>	During playback, the MONITOR switch must be placed in the TAPE position. If it is set in the SOURCE position, the signal from the tape won't be heard.

TIMER RECORDING/PLAYBACK

Timer recording/playback can be made using any audio timer available on the market.

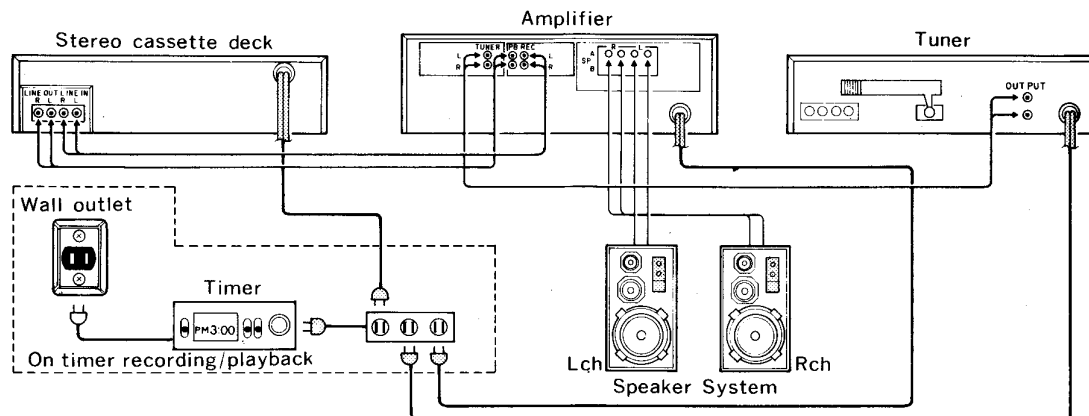

Fig. 13

■ Timer recording procedure

1. Make sure the connections are correct, especially the power supply connections.
2. Turn "on" the power switch of each appliance.
3. Tune the desired station on the tuner.
4. Load the tape for recording. (Make sure the erase prevention tab is not broken off; if it is, cover the hole with plastic tape).
5. Set the Dolby NR switch to the appropriate position.
6. Press the monitor switch to the SOURCE position (▲).
7. Adjust the recording input level.
8. Set the starting position of the tape.
9. Set the timer switch (TIMER) to the "rec" side.
10. Set the audio timer to the desired time. The audio timer will turn the power supply on at the desired time.

*With the above procedures, timer controlled recording can be made. When the preset time comes, the power is supplied and the FM broadcast can be recorded.

Note :

- When making Dolby NR encoded recordings from FM broadcast, set the Dolby NR switch to either B or C. Push the MPX FILTER switch on (▲).
- When the power supply is turned "on" with the timer switch is set to the "rec" side, the auto tuning system will operate first. The EQ and the sensitivity will be automatically adjusted for the tape being used. When the adjustments are completed, the tape will be rewound to the point where the auto tuning was started, followed by the start of recording. When setting the timer, always remember to allow some time for the auto tuning system to operate. (DR-M44HX only)

■ Timer playback procedure

1. Make sure the connections are correct, especially the power supply connections.
2. Turn "on" the power switch of each appliance.
3. Load the pre-recorded tape to be played back.
4. Set the Dolby NR switches to the appropriate positions.
5. Set the monitor switch to the TAPE (■) position.
6. Press the PLAY (▶) key and playback the tape; adjust the playback level.
7. Set the timer switch (TIMER) to the "play" side.
8. Set the audio timer to the desired time. The audio timer will turn the power supply on at the desired time.

*With the above procedures, timer playback can be accomplished. When the preset time comes, the power is supplied and playback will start.

Note :

- Please read the operating instructions for the timer before use.
- If the timer recording or playback is not desired, be sure to switch the timer switch (TIMER) to "off".
- When using timers that allow several "on/off" operations, timer start functioning can continue an unlimited number of times until the tape in the machine is finished.

PAUSE/MUTE KEY

This is an original feature developed by DENON. It enables both pause functioning during playback as well as pause and mute functioning during recording operations. It is especially convenient for adding non-recorded intervals (blank spaces) between selections being recorded.

1. By continuously pressing the PAUSE/MUTE key during recording, non-recorded interval (blank space) will be recorded on the tape.
2. When the PAUSE/MUTE key is released during recording, the deck reverts to the recording standby mode.
3. To restart recording (or playback), push the PLAY key.

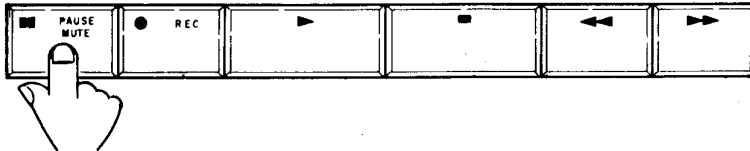

Note When using this function during playback, refer to page 10.
When using this function during recording, refer to page 11.

Fig. 14

DOLBY HX-PRO HEADROOM EXTENSION SYSTEM

This deck is equipped with the DOLBY HX-PRO headroom extension system. Since the system functions automatically during recording, no switching operation or adjustment is required. The system is effective with any type of Normal, CrO₂ or Metal tapes.

The Dolby HX-PRO headroom extension system functions during recording to lift up the saturation level in the treble range. Therefore, most of the treble range components distorted or lost during recording on conventional cassette decks are more faithfully recorded on the new DR-M33HX/M44HX cassette deck.

Features of the DOLBY HX-PRO headroom extension system

- (1) Performance of Normal and CrO₂ tapes can be up-graded closer to that of Metal tapes.
- (2) The dynamic range in the treble is improved significantly.
- (3) Since no decoding in playback is necessary, the improvement can be obviously heard on any hi-fi playback system including portable components and car systems.
- (4) The system functions whether the Dolby B/C NR is engaged or not.

DOLBY C NOISE REDUCTION SYSTEM

- The Dolby noise reduction system substantially reduces the tape background noise (hiss) inherent in the cassette medium. Dolby B NR is most widely in use. However, Dolby C NR is a much more recent development and represents a significantly improvement over Dolby B NR.
- Tape background noise consists primarily of high frequency information which is particularly annoying during soft passages. The Dolby NR system increases the level of low volume mid and high frequency signals during recording and reduces the level of these signals by an identical amount during playback. As a result, the playback signal is identical to the original source signal, but the level of background noise generated by the tape is greatly reduced.
- The operating principle of Dolby C NR is similar to that of B except for the encoding/decoding response curves. The noise reduction effect obtained by Dolby C NR is up to 20dB, compared to 10dB with Dolby B NR. In addition, Dolby C NR uses an antisaturation network and spectral skewing circuitry, and significantly improves the dynamic range in the mid to high frequencies.

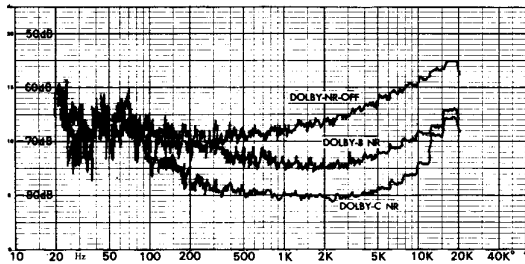

Fig. 15

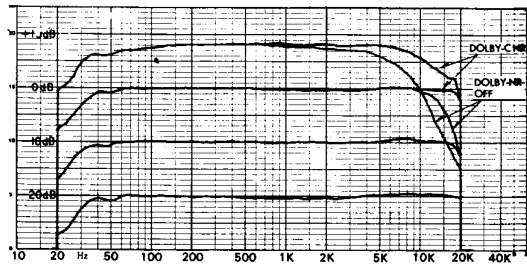

Fig. 16

MAINTENANCE

■ Removing the cassette compartment cover

It will be more convenient if the cassette compartment cover is removed during the cleaning of the pinchroller and heads, or during demagnetizing of heads.

Follow these procedures:

1. Press the EJECT button to open the cassette compartment.
2. Hold only the cover of the cassette compartment and pull it up. The compartment cover is removed from the front. (Fig. 17)
3. Replace and lock the cassette compartment. The heads and the pinchroller will be easily accessible.

When attaching the cassette compartment cover, reverse the above procedure.

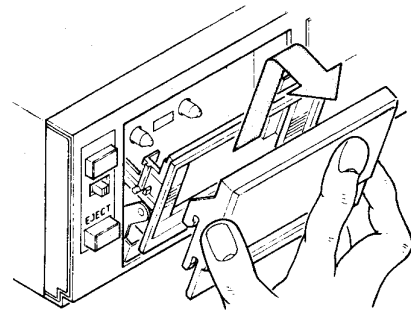

Fig. 17

■ Head Cleaning

After long usage, tape coating or dust may adhere to the heads causing deterioration of sound. Clean them regularly. Use a cotton swab moistened with cleaning solution (such as alcohol). (Fig. 18)

Note:

1. Some cleaning cassettes on the market have a strong abrasive effect and scratch the heads. Use cotton swabs instead of cleaning cassettes.
2. Since the use of metal tapes is apt to collect more dust on the heads, clean the heads more often to enjoy optimum sound.

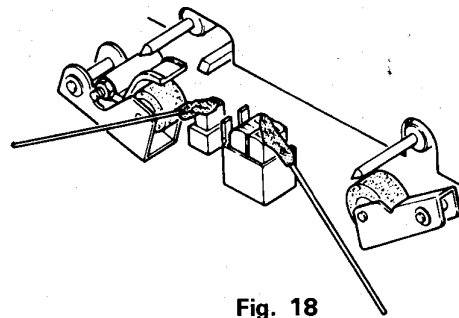

Fig. 18

■ Cleaning the pinchroller and the capstan

If the pinchroller or the capstan accumulate dust, tape transport may become unstable resulting from slippage during recording or playback. The tape can also be damaged by being rolled up around the capstan.

Clean them with a cotton swab or a soft cloth moistened with cleaning solution (such as alcohol). (Fig. 19)

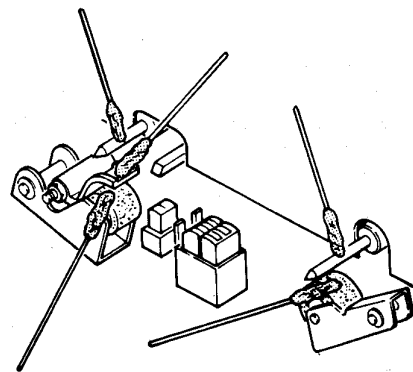

Fig. 19

■ Demagnetizing the heads

The heads may become magnetized after long usage or by having a strongly magnetized object brought near them. The result is a generation of noise, loss of the high frequency range, or erasing the treble components of pre-recorded tapes and adding noise.

Demagnetize the heads on a regular basis.

■ Procedure

1. Be sure to turn "off" the power supply.
2. Turn the demagnetizer "on" while it is more than 30cm away from the heads. Bring the demagnetizer near the heads and slowly move it in a small circle four or five times.
3. Slowly move the demagnetizer away from the heads and turn "off" the power of the demagnetizer when it is about 30cm away from the heads.

SYMPTOMS OFTEN MISTAKEN AS BREAKDOWNS

Make sure of the followings before you consider any malfunctions :

1. Are all the connections correct?
2. Is the set being operated correctly in accordance with the operating instructions?
3. Are the speakers and amplifiers functioning correctly?

If the tape deck still does not function properly, check it again, using the check list below. If the symptom does not correspond to the check list, please contact your DENON dealer.

Symptom	Cause	Remedy
Tape does not run	Power cord is off. Tape is completely wound up. Tape is loose. Cassette is not loaded properly. Defective cassette.	Check power cord. Rewind tape. Tighten tape with pencil, etc. Load cassette properly. Replace cassette.
Tape is not recorded when recording button is pressed.	No cassette is loaded. Erase prevention tab is broken off.	Load cassette. Cover hole with plastic tape.
Sound is warbled or distorted.	Heads, capstan or pinchroller are contaminated. Tape is wound too tight. Recording input level is too high. Tape is worn out and has "drop-outs".	Clean them. Fast forward or rewind to loosen tape winding. Adjust recording input level. Replace tape.
Excessive noise.	Tape is worn. Heads, capstan or pinchroller are contaminated. Heads are magnetized. Recording input level is too low.	Replace tape. Clean them. Demagnetize heads. Adjust recording input level.
High frequency (treble) is emphasized.	Dolby NR switch is set improperly.	Set Dolby NR switch properly.
High frequency (treble) is lost.	Heads are contaminated. Tape is worn.	Clean them. Replace tape.
Auto tuning is inoperative (DR-M44HX only)	Erase prevention tab is removed.	Cover the erasure prevention tab hole with plastic tape.
When a CrO ₂ or metal tape is placed in the deck, a different tape indicator comes on.	The cassette housing is of an older design without tape type detection holes.	Use the latest cassettes with tape type detection holes.
The cassette tape cannot be removed.	If the power switch is turned off in either the recording or playback mode, and the unit is stopped, there may be cases when the cassette cannot be removed, even if the EJECT button is pressed.	Turn the power switch ON again, and then press the stop (■) key. Then, in the stop mode, press the EJECT button to remove the cassette tape.